

GRP Moulded Accessories



...when reliability matters

Contents

GRP Overdoor Canopies

Cheltenham 730 & 880	4
Carisbrooke, Tamworth, Warwick, Ripley	5
Stafford, Rockingham, Elsdon, Ilkley	6
Castledene, Sherbourne, Richmond, Balmoral Shell	7
Balmoral Plain, Berkley Range	8

GRP Bow Canopies

Base Units

Door Surrounds

Garden Room Roofs

Columns

Concept Canopy

Flexi-Roof Modules

Porch Roofs

GRP Brackets and Corbels

Load Bearing Brackets

Load Bearing Solid Resin Brackets

GRP Organgery Roof Module

Miscellaneous

All measurements in metric unless stated

We reserve the right to amend any sizes as necessary

Cheltenham 730

Traditional canopy with clay tile design in a choice of terracotta or slate-grey finish. Fully detailed grained soffit and fascia. Includes GRP brackets.

Shown with "T" bar option and grey tiles GRP brackets. (BRG7).

Available in 1520, 1935 and 2335mm overall widths.

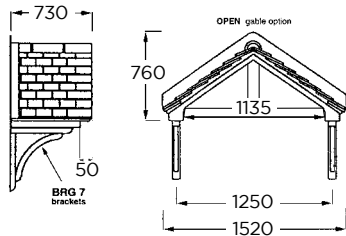

Carisbrooke

Closed gable tiled canopy in a choice of terracotta or slate-grey tile finish Woodgrain boarded gable and soffit. Shown with fully stained GRP soffit & brackets.

Fleur-de-Lys option available GRP Brackets (BRG 7). Single door size only.

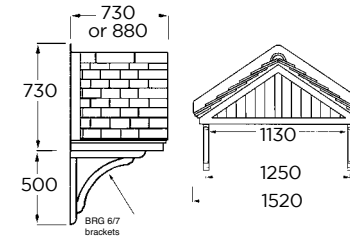

Cheltenham 730

Traditional canopy with clay tile design in a choice of terracotta or slate-grey finish. Fully detailed grained soffit and fascia. Includes GRP brackets.

Shown with Fleur de Lys option and terracotta tiles GRP brackets. (BRG7).

Available in 1520, 1935 and 2335mm overall widths.

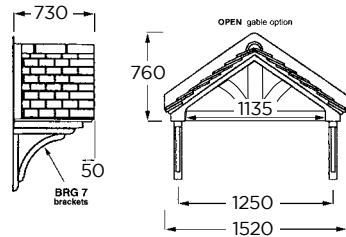

Tamworth

A simple monopitch canopy available to any door width, an effective solution.

Shown with brown resin brackets and terracotta tile top.

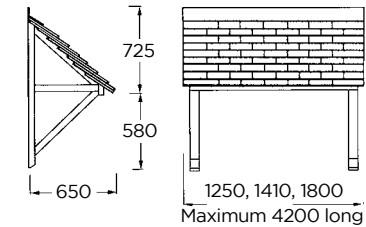

Cheltenham 880

Traditional canopy with clay tile design in a choice of terracotta or slate-grey finish. Fully detailed grained soffit and fascia. Includes GRP brackets.

Shown with with open front option and grey tiles GRP brackets (BRG6).

Available in 1520, 1935 and 2335mm overall widths.

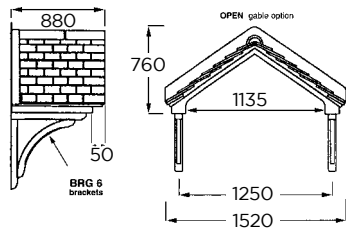

Warwick

Flat topped lead look canopy with smooth white fascia incorporating period detailing.

Available in white, brown, oak or rosewood. Includes GRP corbels (BRG 8 shown).

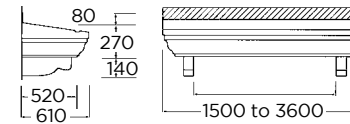

Cheltenham 880

Traditional canopy with clay tile design in a choice of terracotta or slate-grey finish. Fully detailed grained soffit and fascia. Includes GRP brackets.

Shown with Fleur de Lys option, black frame and terracotta tiles GRP brackets. (BRG6).

Available in 1520, 1935 and 2335mm overall widths.

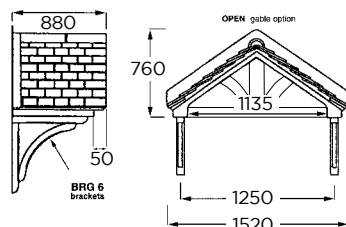

Ripley

Flat topped lead look canopy with scalloped edge detail, smooth white fascia incorporating period detailing.

Available in white, brown, oak or rosewood. Includes GRP corbels (BRG 8 shown).

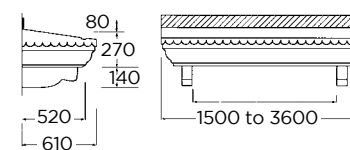

Quality GRP Overdoor Canopies

Quality GRP Overdoor Canopies

Stafford

Flat smooth white canopy with detailed fascia. Available in white, brown, oak or rosewood.

Brackets not included with this canopy but are available on request.

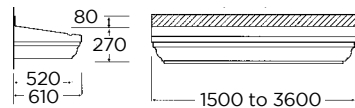

Castledene

Detailed denture fascia with slight textured GRP soffit. We offer solid top or (built-in gutter

options as shown.) Available in white or brown, oak or rosewood.

Lead look top optional.

Available with a range of brackets.

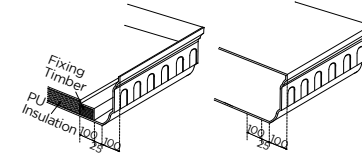
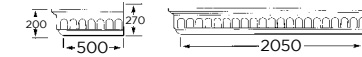

Profile of Gutter Version Profile of Solid Version



Rockingham

Elegant Victorian style door canopy in a smooth finish incorporating fully moulded brackets.

Also available without brackets. Lead look top optional. Available in white, brown, oak or rosewood.

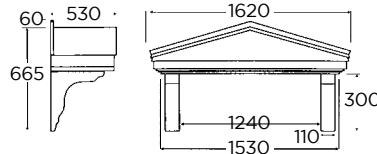

Sherbourne

A realistic rolled lead-topped door canopy. Suitable for bay tops. Smooth fascia detail.

Available in white, brown, oak or rosewood.

Includes GRP brackets (BRG5) with steel inserts.

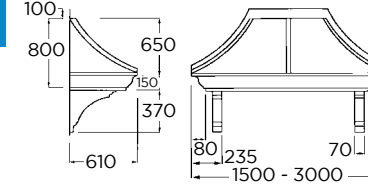

Elsdon

Clay tiled effect door canopy with a flat fascia and ceiling. Supplied without brackets. Can be fitted with corbel brackets BRG4, BRG5 or BRG11 from our range as optional extras.

Tiles available in terracotta or grey colours. Also a choice of white, brown, oak or rosewood underside.

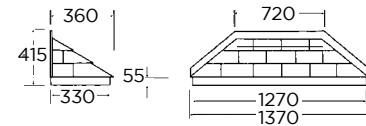

Richmond

Manufactured to any size. Shown with a realistic lead top finish, smooth fascia detail.

Available in white, brown, oak and rosewood.

A great bay roof, fully insulated ceiling with extra soffit to avoid plastering.

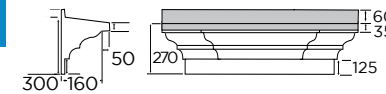

Ilkley

Realistic lead-effect canopy with ceiling tray incorporating fully moulded brackets.

Available in a white, brown, oak or rosewood underside.

Also available without brackets.

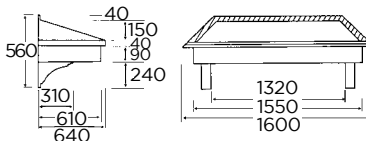

Balmoral Shell

Available for single door use only.

A distinctive shell detail canopy with lead look top.

Shown with brackets (BRG4 or 5). Available in white, brown, oak or rosewood.

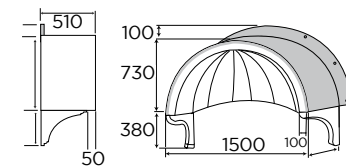

Quality GRP Overdoor Canopies

Balmoral Plain

Arched canopy with lead look top.

Ideal for an arched door or feature.

Shown with brackets (BRG4 or 5). Available in white, brown, oak or rosewood.

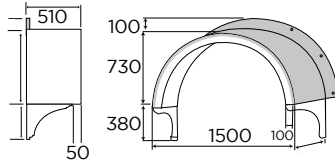

Berkley

Mono pitched canopy with traditional clay-tile effect in choice of colours, with close boarded gable and soffit detailing.

Includes GRP brackets (BRG7).

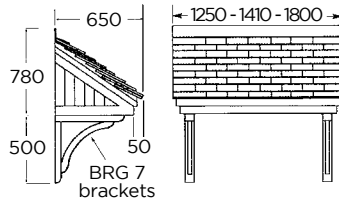

Berkley Extended

Mono pitched clay-tiled effect in choice of colours, with close boarded woodgrained gable and soffit detailing.

Includes GRP brackets (BRG7).

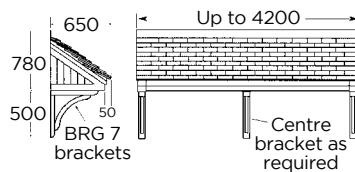

All overdoor canopies are supplied with fixing kit and instructions

- Beautiful Moulded Design • Fast Easy Installation
- Made in Strong Rigid Fibreglass • Totally Maintenance Free
- Transforms & Protects any Doorway • Delivered Approx' 7-14 Days
- Full 10 year Guarantee • Available in many colour variations

Quality GRP Bow Canopies

The answer to your fitting problems.

All we need is your brickwork opening size.

Manufactured in strong rigid G.R.P this beautifully designed canopy is available to fit openings between 1500 and 3400.

Available in three shades of white, chocolate brown, oak and rosewood. Cuts fitting time to a minimum and can be completed by an installer, eliminating lead work and plaster ceilings etc. No need for specialist contractors to finish the job.

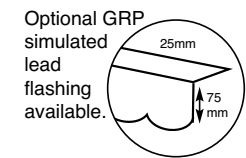
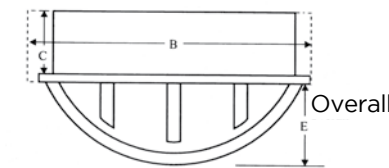
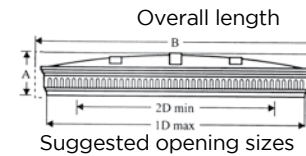
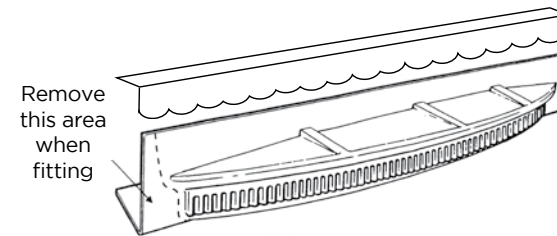

New Lead Look Flashing Available

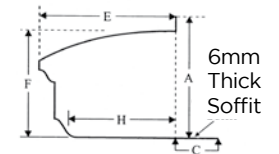
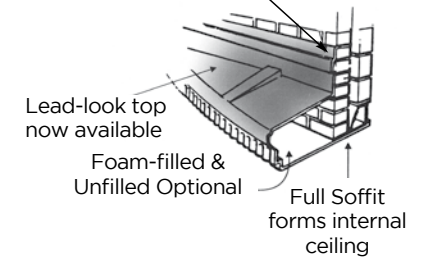

The Answer To Your Bow Window Installation Problems

- Fast Easy Installation
- Totally Maintenance Free
- Strong Rigid Fibreglass
- One Piece Leak-Proof Moulding
- Foam-Filled / Unfilled Optional
- Dark Brown & Light Oak, Rosewood and 3 Shades of White
- Any Opening from 1500 to 3400
- Next Day Delivery Available

MODEL	DIMENSIONS							PROJECTION
SIZE	A	B	C	1D	2D	E	F	H
1800 Canopy	250	2360	300	1900	1500	256	200	175mm
2400 Canopy	300	2830	300	2500	1900	390	250	310mm
2800 Canopy	310	3150	300	2800	2500	460	260	360mm
3400 Canopy	330	3730	300	3400	2800	590	280	490mm

Mk. 1 Base Units

Manufactured from strong rigid glass reinforced plastic, are designed for fast and easy installation. Fully moulded bottom with bracket attached in one piece with a 12mm mahogany plywood window board. For use in conjunction with our Bow Bay Canopies.



SIZE	A	B	C	D	E	F	G
1800 BASE INC. 1 BRACKET	2130	210	150	330	50	530	20
2400 BASE INC. 1 BRACKET	2440	370	230	330	50	650	20
2800 BASE INC. 2 BRACKET	2850	340	230	330	50	650	20

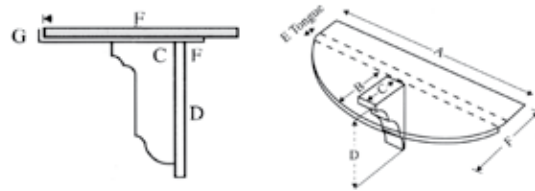

Available in three sizes: • 1800mm • 2400mm • 2800mm.

Mk. 2 Base Units

This revolutionary development in GRP closed tool process allows us to make a complete double sided finished base with no seams or joins. The first base unit ever to be made by this new process. It's never been easier to install a bow window, saving you time and money.



SIZE	A	B	C	D	E	F
1800 MK 2 BASE INC. 1 BRACKET	2180	30	150	330	40	510
2400 MK 2 BASE INC. 1 BRACKET	2670	30	230	330	40	660

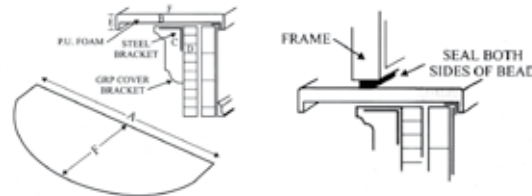

Base Units are available in:

- 3 Shades of White: Standard, Ultra, Deepas
- Chocolate Brown, Light Oak and Rosewood

Victorian Winged

We have developed a unique design enabling the winged ends of the surround to be extended to suit your application.

This allows you the flexibility to order this beautiful surround to fit your own door width.

Brighten up your garage with this version of our great looking surround in the Victorian Style. Also available in the flat-top Georgian style.

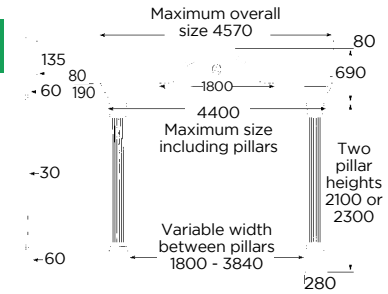

Victorian Portico

Manufactured in a Satin finish.

With smooth pillars this elegant design will transform the appearance of any door and side lights.

Available in white, brown, oak and rosewood.

Shown with lead top.

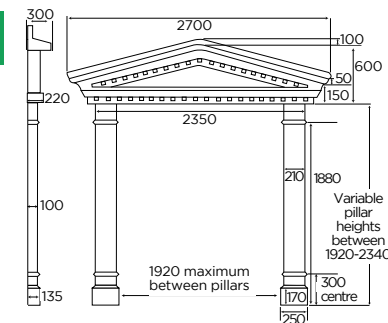

Victorian

Popular design surround with fluted pillars.

Easy to install on any single door opening.

Available in white, brown, oak and rosewood.

Shown with lead top.

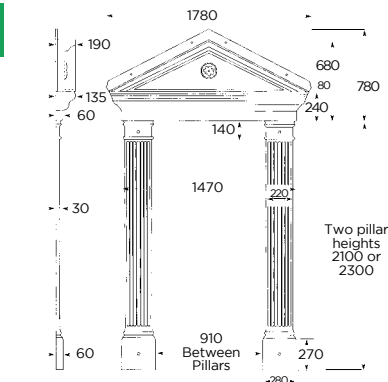

- Beautiful Moulded Design • Fast Easy Installation • Fully Guaranteed
- Made in Strong Rigid Fibreglass • Totally Maintenance Free
- Transforms any Doorway • Delivered Approx' 7 Days
- Available in 3 shades of White, Brown, Light Oak & Rosewood

Georgian

Transform your door with this surround.

Georgian top available in any length up to a maximum of 2990mm in one piece.

Pillars are also available separately.

Lead look top optional.

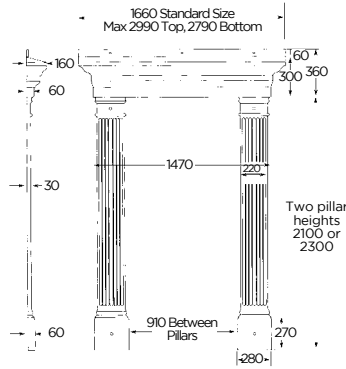

Designed to make life easier!

Garden rooms can be used in conjunction with our flexi-porch roofs to create many different variations in design and shape.

Fully insulated roof 0.2U Value, this keeps your conservatory cool in summer and warm in winter, eliminating condensation problems.

Don't sit in a greenhouse, relax in a garden room.

Our unique drain hopper can be fitted at any point on the gutter allowing you more flexibility.

Available in: 5, 7, 9, 11 and 13 segment size. Special variations in length made to order. Normal delivery approx' 7-14 days.

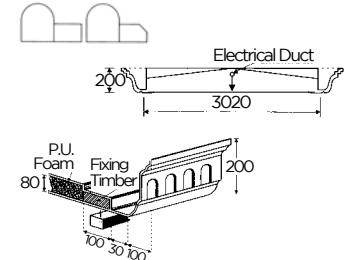
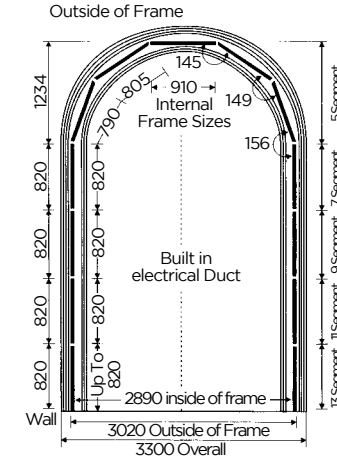

- One Piece Leak-Proof Moulding • Built in Gutter System
- Built in Lighting Duct • Fast Easy Installation • Fully Guaranteed
- Available in 3 shades of White, Brown, Oak and Rosewood.
- Totally Maintenance Free • Delivery Approx' 7-14 days

Edwardian

A modern surround in a satin finish. The top can be up to a maximum size of 3150mm overall.

Pillars are also available separately.

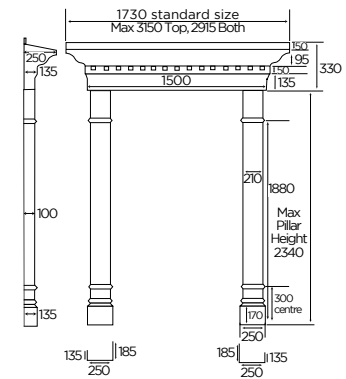

Victorian Portico

A fantastic one piece roof that creates an instant portico by using round columns or window frames for a fully enclosed porch.

Available with decorative plaque option.

Columns Options:

	Height	Width
Full Plain Column	2370mm	330mm
Half Plain Column	2370mm	330mm
Full Fluted Column	2495mm	350mm
Half Fluted Column	2495mm	350mm
Half Flat Fluted Pillar	2100mm	276mm
Half Flat Fluted Pillar	2300mm	276mm

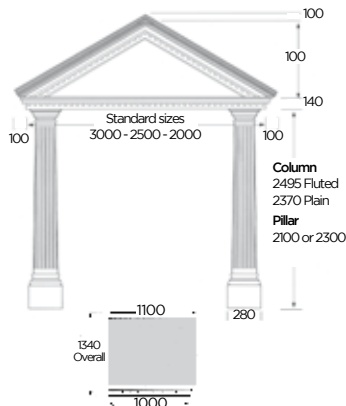

- Beautiful Moulded Design • Minimal Fitting Time • Lead-Look Top
- Made in Strong Rigid Fibreglass • Totally Maintenance Free
- Available in White, Brown, Oak or Rosewood • Fully Guaranteed for 10 Years

Columns

Transform any entrance with our round or half round columns.

These beautifully moulded columns are lightweight and easy to handle. They can be used in many building projects, including porches, and porticos.

Further strength for load-bearing properties can be added by filling the centre of the columns with steel rods and concrete, creating a real-feel concrete column that will retain its good looks with no maintenance. Columns can be used with our canopies, or as part of your own design.

Both columns are also available in Half-Round profile.

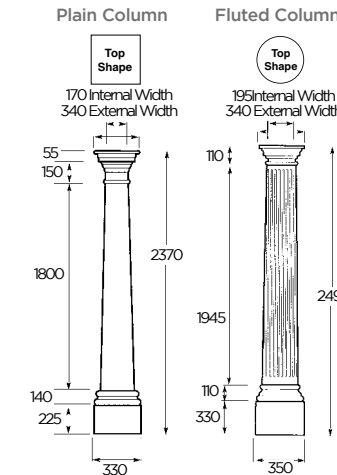

- Beautiful Moulded Design • Fast Easy Installation
- Made in Strong Rigid Fibreglass • Delivery Approx' 7-14 Days
- Totally Maintenance Free • Fully Guaranteed

Many households have two or even three cars. An average size garage usually has space for only one car to be protected. What happens to mum's, your daughter's or your son's car? They are left outside, open to all the elements.

Concept Canopy will make such a difference to your home and the way you live. Whether you choose a Carport, Covered Walkway, Children's Play Area or a stylish Patio Canopy. The construction is of tough and reliable glass reinforced plastic, the building material of the future. Being self-coloured your Concept Canopy needs no painting or maintenance ever. (Supplied with all fixings needed.)

Your canopy will keep its good looks for years and years without continual upkeep. The tough translucent roof panels allow natural daylight through, so if your canopy is above your kitchen window, patio or living room, adequate daylight still enters your home.

Adds value to your property... The Concept Canopy has undergone rigorous testing procedures in simulated and actual installations over many years. Monitoring of test models is continuous and no component deterioration has been detected. Concept Canopy requires no ground preparation and in most cases planning permission is not necessary. It immediately becomes a welcome addition to any house or bungalow.

Installation... The canopy installation can be carried out by trained installers in a few hours with no fuss and no mess. All you need to maintain the elegant looks is an occasional wipe clean. (Supplied with all fixings). Concept Canopy is designed on a modular basis which means that you can increase the area of the cover at any time and there are no support pillars needed, giving maximum protection for all the vehicles you are ever likely to own.

Sizes available in 1600mm increments.

- Rigid Glass Reinforced Plastic • Withstands Snow Loads of 1690kg • Totally Maintenance Free
- Completely Self-Supporting • Withstands Wind Speeds of 146mph • Available Within 7-14 Days

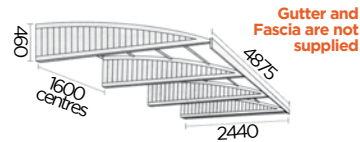

Flexi-Roof Modules

Ideal for porches, extensions & canopies.

Constructed from glass reinforced plastic. Each roof is made to your exact requirements. Max size to the outside of the fixing timber 6000 x 3100mm.

Cut-outs can be built in, as well as blank ends to allow the module to fit against side walls.

This product is also compatible with our garden room roofs, allowing you to create many shapes of garden room.

Supplied to your external frame sizes, we work out the overhang to suit your frame. You simply lift the roof on top of the frames and screw up into the fixing timber around the outer frame layout.

Even lighting is simple to install due to the built-in conduit. Fitting can be completed in minutes, creating a beautiful, strong, lightweight porch. Fully insulated to a 0.2 U Value.

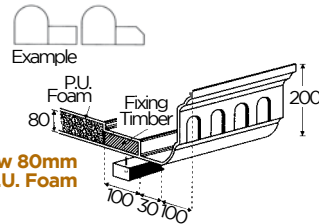
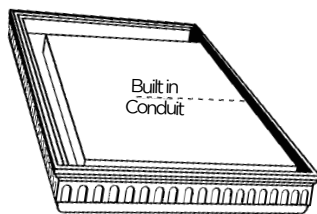

- Available in Various Colours: • 3 Shades of White, Chocolate Brown, Light Oak and Rosewood
- Split colours available, i.e. Brown Outer with White Ceiling, etc. • Normal delivery approx 7-14 days.

Dentil Moulded Fascia

Porch Roof.

Fully insulated with built in gutter system and lighting duct.

Available as a flat roof, sloping lead look roof or tiles roof (optional).

Shown with a tiled roof option.

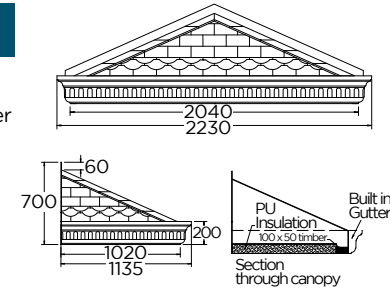

Lincoln Moulded Fascia

Porch Roof.

Fully insulated with built in gutter system and lighting duct.

Available as a flat roof, a sloping lead look roof or tiled roof (optional).

Shown as a flat roof.

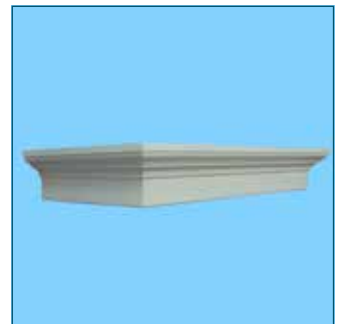
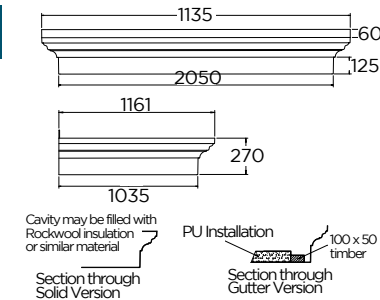

Hastings Moulded Fascia

Porch roof.

Fully insulated with built in gutter and lighting duct.

Available as a flat roof, a sloping lead look roof or a tiled roof (optional).

Shown with tiled roof option.

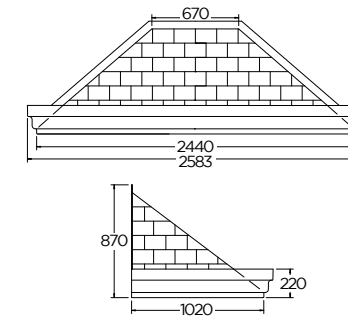

The Suffolk

Traditional tile effect hip-roof canopy. With flat fascia and soffit.

Available with a range of brackets.

Also available with dentil moulding as Castledene (see page 7). Suitable for mounting above frames as a porch.

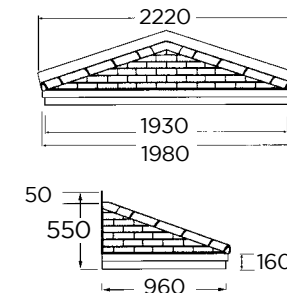

The Conisborough

Conisborough Roof shown with fluted columns (optional).

Can be fully insulated as required to be used as a porch assembly on top of frames, forming a great enclosed porch.

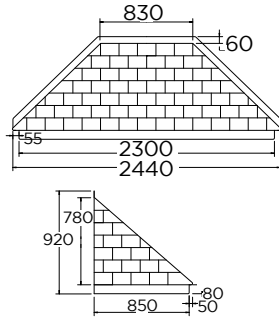

The Berkley 1420

(1420mm projection.) Shown as part of a porch assembly with frame.

A quick, realistic roof fitted in a fraction of the time.

Available in white, brown, oak or rosewood.

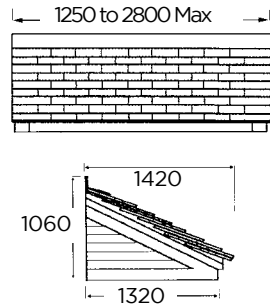

The Berkley Bay Top

Same details as the standard Berkley 650.

Insulated base forms a great bay top in record time.

Available in white, brown, oak or rosewood.

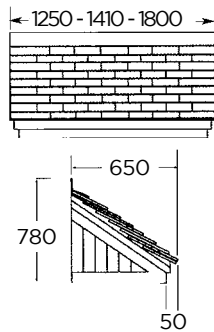

- Beautiful Moulded Design • Fast Easy Installation
- Made in Strong Rigid Fibreglass
- Totally Maintenance Free • Delivered Approx' 7-14 Days
- Transforms & Protects any Porch
- Full 10 year Guarantee • Available in many colour variations

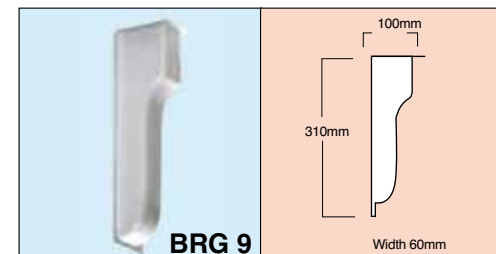
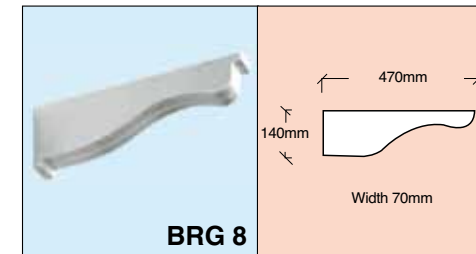
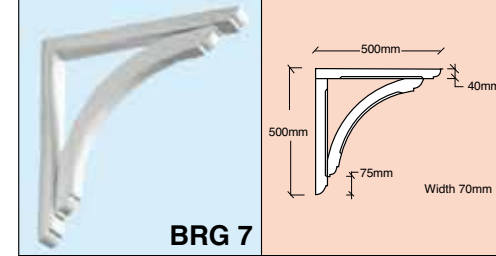
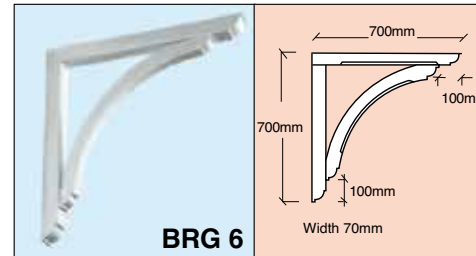
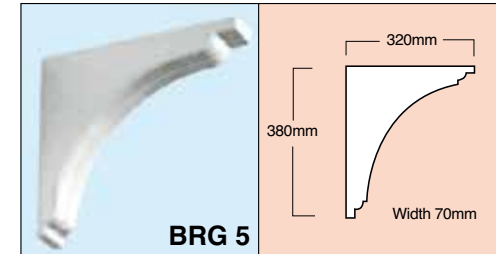
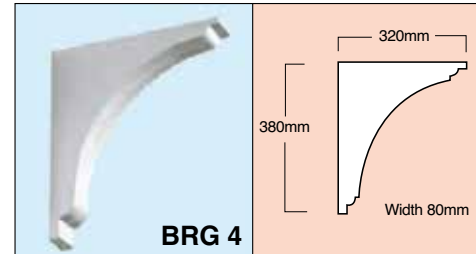
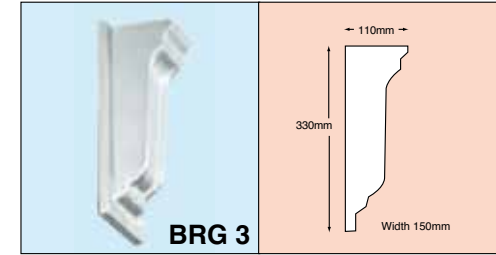
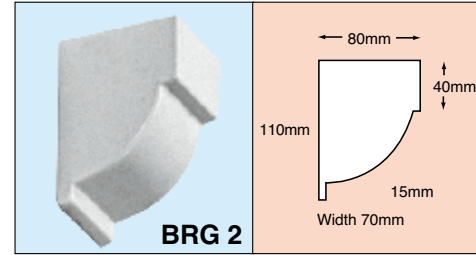

- In a choice of colours
- Fast & easy installation!

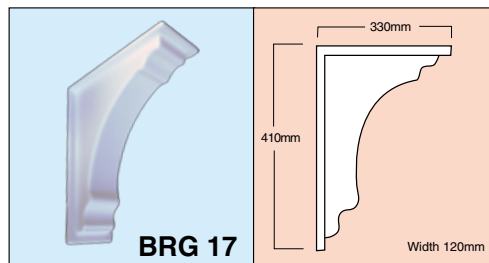
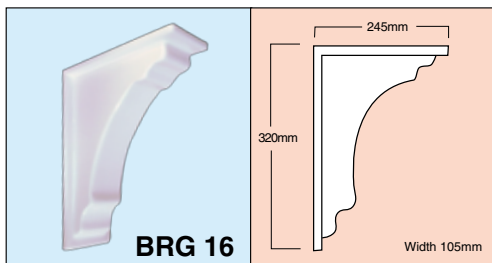
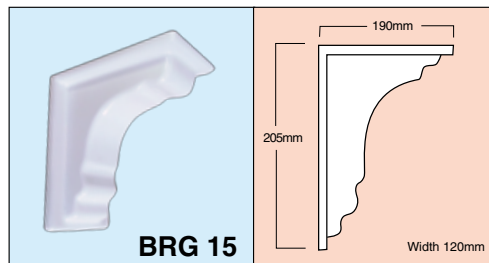
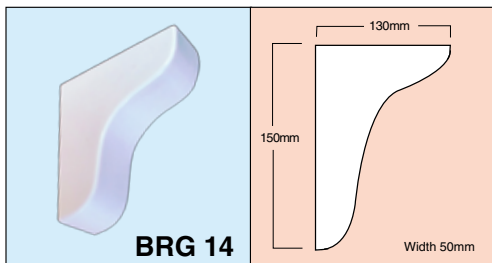
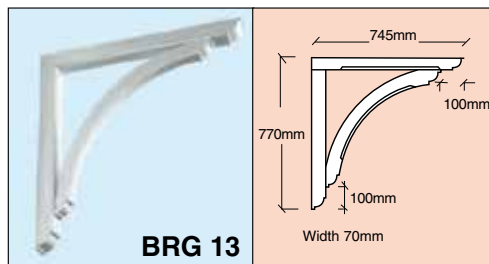
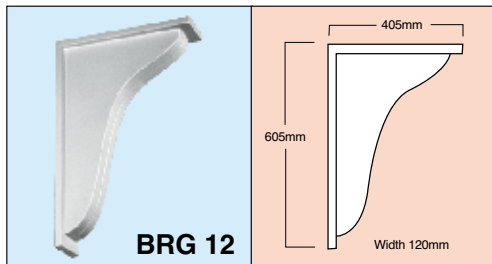
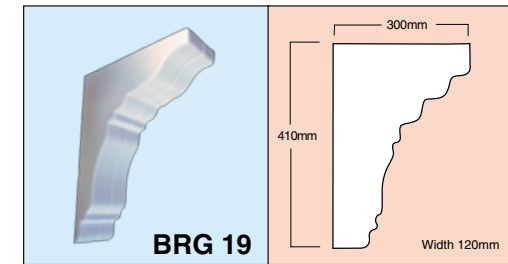
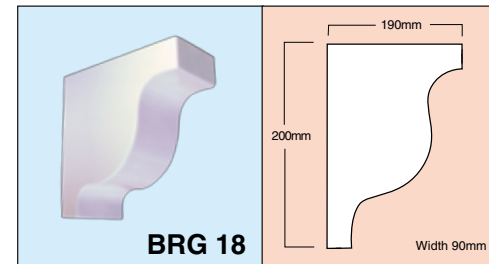
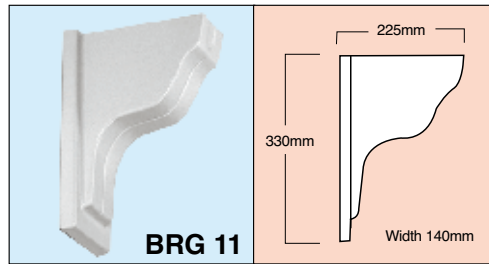
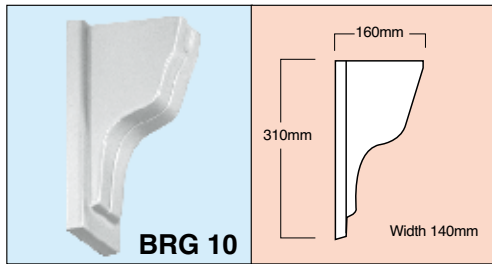

- In a choice of colours
- Fast & easy installation!

Steel Brackets

Rigid load bearing brackets used in conjunction with many of our BRG bracket range. Heavy duty steel, full welded.

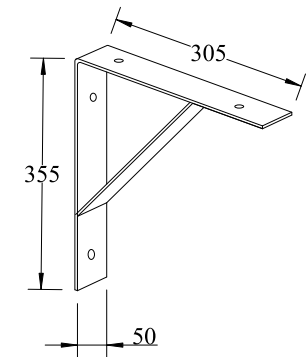

Load Bearing Solid Resin Brackets

Custom made to any size.
Stock sizes available are:

Height (mm) x Projection (mm)
300 x 300
400 x 400
400 x 500
500 x 500
500 x 600
600 x 600
600 x 700
700 x 700
700 x 800
800 x 800

Only available in white or chocolate brown.

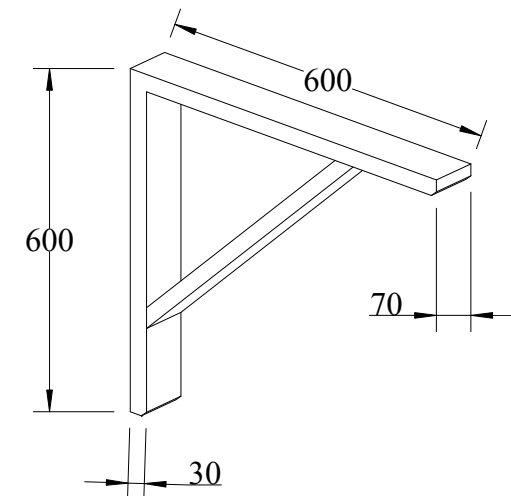

The ultimate solution for a luxurious home extension or conservatory roof.

The roof has been developed to reduce the installation time on site, thereby reducing the overall costs involved. Each section can be manufactured to a maximum size of 6m x 3m external frame size in one piece. Larger roofs can be made in sections and bolted together on site.

Choose your design, fascia style and finish from our durable GRP range, a choice of any RAL colour can be manufactured to suit your needs.

The roof will be fully insulated throughout, structural timber inserts are installed along with built-in lighting duct where required.

Complete with a built-in control system, the roof is maintenance free and covered by our 10 year manufacturer warranty.



Prefabricated GRP Chimney (shown with real brick slips)



Custom Made Dormer



Dovecote



Bell Tower



Quoins (Shown in white and black)



Tiles (3x4 tile shown)

Beautiful Moulded Design • Fast Easy Installation
Totally Maintenance Free • Fully Guaranteed

